

Rev	AWO #	Description	Date	Appr
-		RELEASED	3/30/10	

APPROVED: _____
 DATE: _____ TITLE: _____

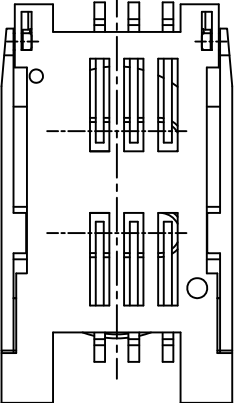

PACKAGED ON TAPE & REEL

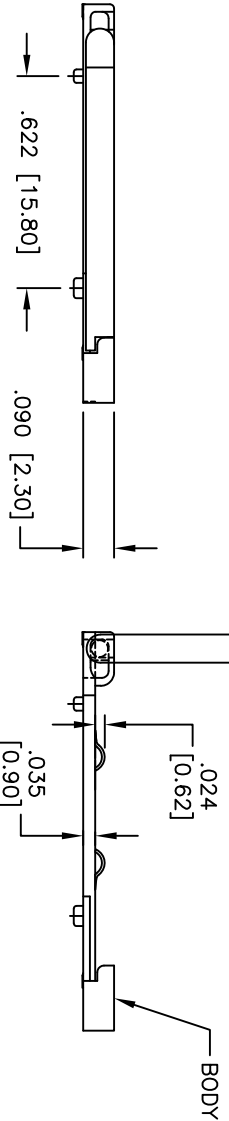
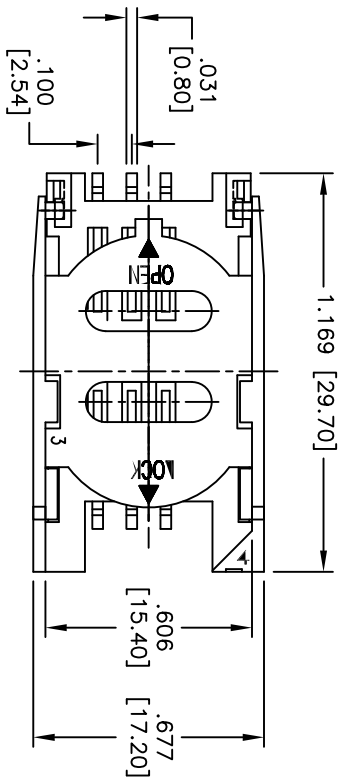
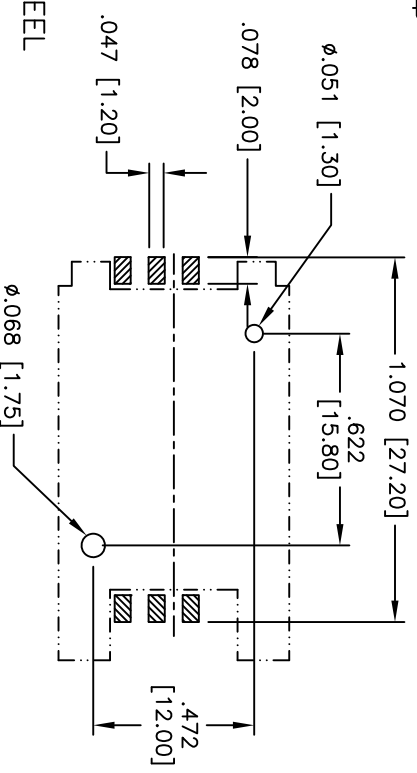

RECOMMENDED P.C.B. LAYOUT
 TOP VIEW

SPECIFICATIONS:

- Material: Insulator: PPS, rated UL 94V-0
- Insulator color: Black
- Contacts: Phosphor Bronze
- Plating: Gold flash over Nickel underplate on contact area, tin over copper underplate on tails.
- Electrical:
 - Operating voltage: 250 VAC max
 - Current rating: 0.5 Amp max
 - Contact resistance: 30 mohms max
 - Insulation resistance: 1,000 Mohms min
 - Dielectric withstanding voltage: 500 VAC for 1 minute
- Temperature Rating: Operating temperature: -25°C to +85°C
- Environmental: Lead free, RoHS compliant
- Recommended soldering temp: 260°C for 5 seconds



UNLESS OTHERWISE SPECIFIED ALL DIMENSIONS ARE IN INCHES [MM]	
TOLERANCES: EXCEPT AS NOTED	HOLDS
.X ± .10	ØX ± .10
.XX ± .020	ØXX ± .015
.XXX ± .015	ØXXX ± .010
APPROVALS	DATE
DRAWN	DY
CHECKED	
APPROVED	

ADAM TECH
 909 Rahway Avenue, Union, NJ 07083
 Phone: 908-687-5000 Fax: 908-687-5710

TITLE: SIM CARD 6 PIN, WITH POST
 W / HINGED COVER, NO SWITCH

SIZE: X PART NO.: SCC-06-SG-HC-NS-T/R

REF: S0009T SCALE: NTS SHEET 1 OF 2